

Audionet

SAM 20 SE

Stereo Amplifier

User's Manual

Contents

1	Preface	5
1.1	Included.....	6
1.2	Transport.....	6
2	Overview front panel	7
3	Overview back panel	8
4	Installation and power supply	9
4.1	Placement	9
4.2	Mains connection	9
4.3	Orientation of mains plug	10
5	Inputs and outputs	11
5.1	Inputs.....	11
5.2	Speaker terminals.....	11
5.3	Preamplifier Output.....	12
5.4	Recording devices	12
5.5	Phono	13
5.6	Headphones socket	13
5.7	Audionet Link.....	13
6	Usage	14
6.1	Powering up	14
6.2	Switching on and off.....	14
6.3	Using Audionet Link	15
6.4	Control elements on the front panel	15
6.5	Volume control.....	16
6.6	Display	16
6.7	Input selection.....	17
6.8	Muting	18
7	Setup menu	19
7.1	Overview setup menu	20
7.2	Select Input.....	20
7.3	Global Setup.....	21

7.3.1	Headphones	21
7.3.2	Display.....	22
7.3.3	Pre Output.....	23
7.3.4	AutoStart	23
7.3.5	By-Pass Mode.....	24
7.3.6	Channel Name	26
7.4	Factory Default Reset.....	27
7.4.1	Overview factory default settings.....	27
7.5	Device Info.....	28
8	Audionet Metal Remote Control.....	29
8.1	Key assignment SAM 20 SE	30
8.2	Changing the batteries	30
8.3	Settings for Audionet preamplifier	31
9	Protection system	33
10	Phono module	34
10.1	Setup	34
10.2	Jumper settings.....	35
10.3	MM pickup systems.....	36
10.4	MC pickup systems.....	36
10.5	Typical setups	36
10.6	Fine tuning	37
10.7	Factory defaults	38
11	Security advice	39
12	Technical data	40

1 Preface

The Audionet Team congratulates you very warmly on your purchase of this very special unit.

Designed to celebrate 20 years of scientific audiophile magic. Enjoy the once more vastly improved sonical capabilities of your SAM 20 SE. We're happy you've found your way to us and will be happy to be your faithful companion on your musical adventures. At the very least until the next celebratory unit will come along, in 2027, for the 30th jubilee.

All the very best,

Dipl.-Volksw. Thomas Gessler
(Managing Partner)

Dipl.-Kfm. Robert Hagemann
(Managing Partner)

Dipl.-Ing. Thomas Pohl
(Head of R&D Hardware)

Audionet components are no marketing products, they are authentic. Conceived and developed with scientific inspiration, professional engineering expertise and a passion for achieving the perfect sound. They are unique creations designed to inspire musical enjoyment and have an excellent reputation amongst all connoisseurs throughout the world. Each and every one of our precision-manufactured devices is individually crafted at our Berlin works by our experienced and passionate workforce.

But before you start listening to your new Audionet SAM 20 SE, please read this manual carefully so you are able to use and enjoy all functions of this unit without drawback on music quality.

1.1 Included

Included you will find the following items:

- the stereo integrated amplifier SAM 20 SE
- the user's manual (that you are currently reading)
- one standard mains power cord
- Audionet Metal Remote Control

1.2 Transport



Important

- Please transport the SAM 20 SE only in the included package.
- Always use the provided cloth bag to prevent scratches on the casing.
- Please allow the SAM 20 SE to adapt to the climatic conditions in your listening room before you switch on the unit for the first time after transport.

2 Overview front panel

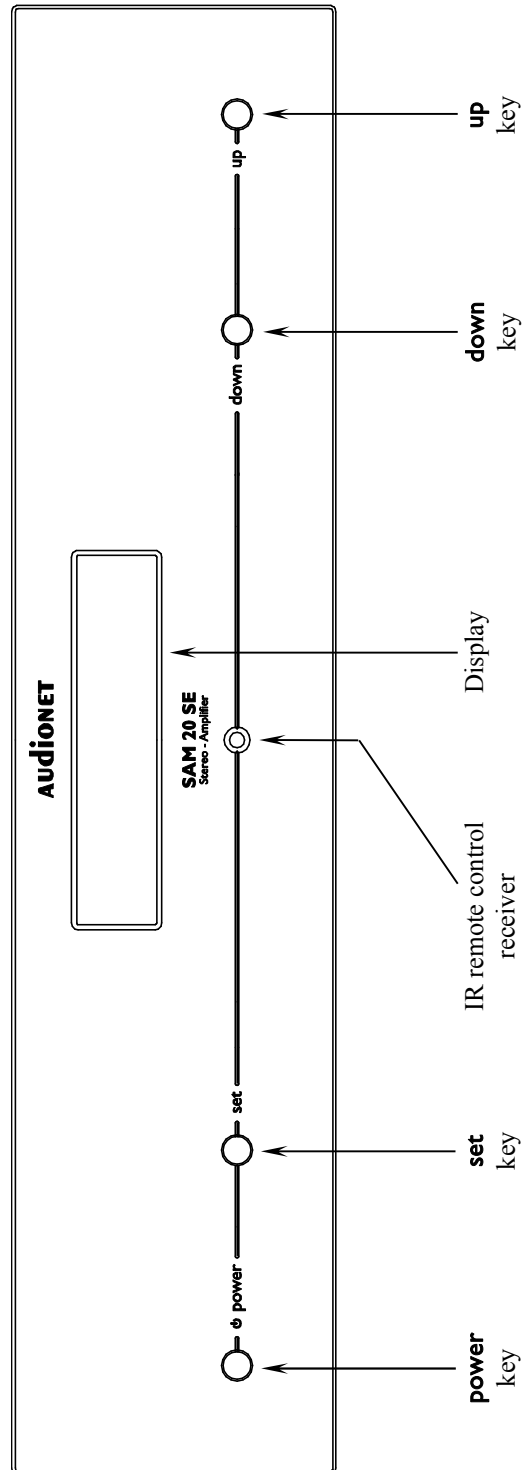

3 Overview back panel

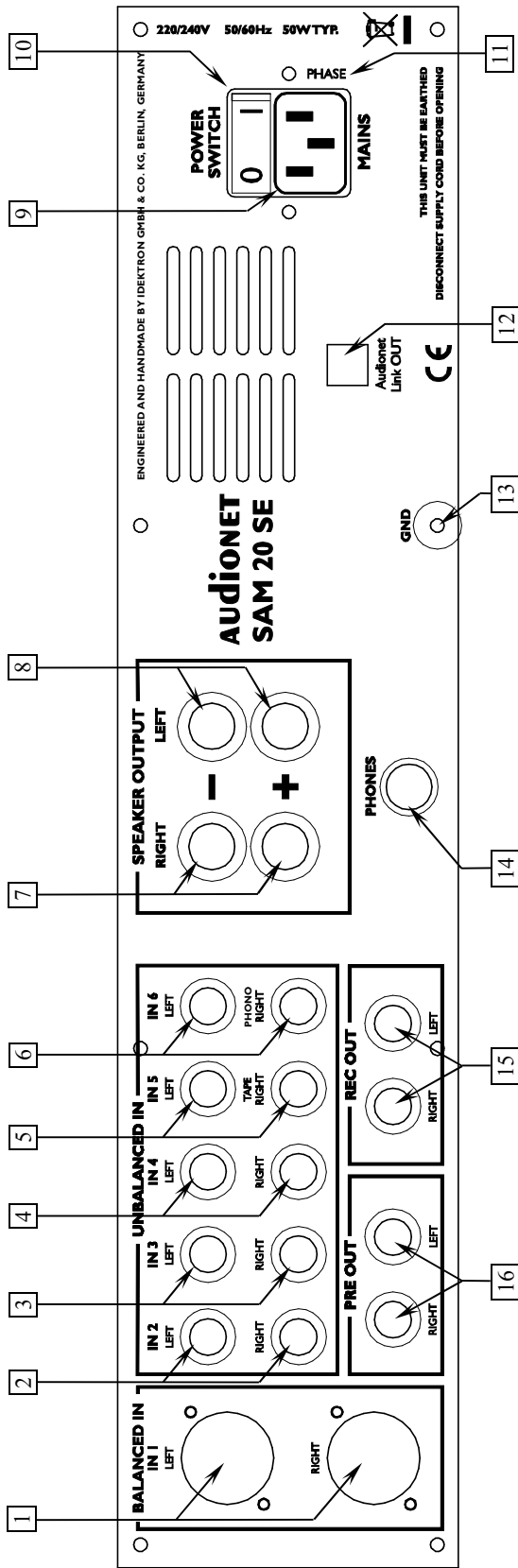

- 1 Balanced input (XLR) no. 1, left/right
- 2 RCA input no. 2, left/right
- 3 RCA input no. 3, left/right
- 4 RCA input no. 4, left/right
- 5 RCA input no. 5, left/right
- 6 Phono input (RCA) no. 6, left/right
- 7 Speaker terminal, right channel
- 8 Speaker terminal, left channel
- 9 Mains input
- 10 Mains switch
- 11 Marking mains phase
- 12 Audionet Link output OUT
- 13 Earth connector for turntable
- 14 Headphones socket
- 15 Recording output **REC OUT**, left/right
- 16 Pre amplifier Output, **PRE OUT** left/right

4 Installation and power supply



Important

- During connecting and removing of sources or amplifiers to the SAM 20 SE all units of your audio system have to be switched off to prevent damage of the SAM 20 SE or any of the other connected units.
- Please make sure that all cables are in absolute best conditions! Broken shields or short-cut cables could damage the SAM 20 SE and/or any other connected unit.

4.1 Placement



Important

- It is recommended to place the SAM 20 SE into a high quality rack or onto a stable table.
- Do not expose the unit to direct sunlight.
- Do not cover the ventilation slots.
- Do not place the SAM 20 SE in close range to heat sources like radiators.
- Do not place the SAM 20 SE on top of other units, especially not on top of power amplifiers, pre amplifiers or similar that produce heat. Both units could suffer damage from thermal overload.
- Do not use the unit in places where it is exposed to vibrations.
- Do not place the unit close to loudspeakers or into the corner of a room where it is exposed to high levels of sonic energy, which might reduce the sound quality of the unit.

4.2 Mains connection

The mains input * is on the back panel of the SAM 20 SE. To connect the unit to mains use the included mains power cord. If you prefer to use a different power cord make sure that it meets the specifications for your home country.

* see numbers in section 'Overview back panel' on page 8.



Important

- **The electrical specifications of your home country must meet the electrical specifications printed onto the back panel.**
- The SAM 20 SE is a Class I unit and must be earthed. Please ensure a stable earth connection. Phase ('hot' pin) is marked on the back panel ('PHASE') **11**.
- If you connect the mains power cord please make sure that mains switch **10** at the back panel is switched off.
- Never pull the mains plug while the SAM 20 SE is switched on! Before you pull the mains power cord off its socket **9** at the back panel, power down the unit to stand-by mode and switch off the unit using mains switch **10**.

Only in cases of extended absence – like vacations – or if massive trouble on the mains power is to be expected you should switch off the SAM 20 SE from the mains using the mains switch **10**. To disconnect the unit completely from mains pull the mains plug.



Tip

- The use of high quality mains power cords could improve sound quality. Ask your local dealer for more information.

4.3 Orientation of mains plug

The correct polarization of mains is important for reasons of audio clarity and stability. Please connect the mains power cord so that the hot pin of the wall outlet is connected to the pin of the mains input **9** marked 'PHASE' **11**.

5 Inputs and outputs



Important

- During connecting and removing of sources or amplifiers to the SAM 20 SE all units of your audio system have to be switched off to prevent damage of the SAM 20 SE or any of the other connected units.
- Please make sure that all cables are in absolute best conditions! Broken shields or short-cut cables could damage the SAM 20 SE and/or any other connected unit.

5.1 Inputs

The SAM 20 SE is equipped with four RCA inputs **2** to **5** and one balanced (XLR) input **1** for connecting signal sources at line level. RCA input **6** is dedicated to connect a turn table.

Please connect the left and right input of the same number printed on the back panel of the SAM 20 SE to the corresponding output of the source you would like to connect to the SAM 20 SE.

5.2 Speaker terminals

Connect your speakers to the terminals **7** and **8** on the back panel of the SAM 20 SE. You can use banana plugs or spades as well as simple cable ends. Look out for the correct connection of your speaker cables. Usually, the terminals of your speakers are marked '+' and '-'. The SAM 20 SE uses the same marks.



Note

- Wrong speaker polarization will result in severe loss of sound quality.
- In case you would like to bi-wire your speakers please insert the cable to the tweeters from the rear using banana plugs and mount the cables to the bass speakers from the side. In doubt please ask your dealer for assistance.



Important

- **Although the SAM 20 SE has an effective protection system to prevent damage to the circuits, switch off the unit while working on the speaker and/or audio cables.**
- The nominal loudspeaker impedance has to be at least 4 Ohms or higher.
- Never use force or tools tightening the terminal screws.

5.3 Preamplifier Output

The SAM 20 SE is equipped with a pair of RCA preamplifier outputs to connect e.g. an additional amplifier or a subwoofer.

Please use high quality interconnectors to connect the **PRE OUT** 16 of your SAM 20 SE with an additional amplifier or subwoofer.

5.4 Recording devices

You can connect one recording device to the SAM 20 SE for recording and playback.

Connect your recording device (like DAT or tape recorder) to the recording output **REC OUT** 15 of the SAM 20 SE. For playback please connect your recording device only to input no. 5 **IN 5** 5 of the SAM 20 SE, if it is also connected to the output **REC OUT** 15 of your SAM 20 SE. If you select input no. 5 **IN 5** 5 the output **REC OUT** 15 is switched off to prevent any feedback loops between your recording device and the SAM 20 SE.

Please use inputs no. 1 1 to no. 4 4 and no. 6 6 to connect sources you like to record from. With these inputs the recording output **REC OUT** 15 is always active.

5.5 Phono

The SAM 20 SE is equipped with a phono preamplifier board. Use the input no. 6 **IN 6** [6] marked as **PHONO** to connect your turntable to the SAM 20 SE. Connect the earth wire of your turntable to the earth connector **GND** [13]. For further information on the phono preamplifier board please refer to section '*Phono*' on page 34.



Important

- Input no. 6 **IN 6** [6] must only be used to connect a turntable.
- Input no. 6 **IN 6** [6] is not available for By-Pass mode (see section '*By-Pass Mode*' on page 24).

5.6 Headphones socket

A 6.3 mm headphones socket [14] is located at the rear of your SAM 20 SE. The signal at this socket can be switched on and off to allow the headphones to be plugged in permanently. Switching is easily done on the front panel. Please refer to section '*Headphones*' on page 21.

5.7 Audionet Link

For your convenience, the SAM 20 SE can switch on/off all other Audionet units (e.g. power amplifiers) connected via Audionet Link by a simple touch on the remote control or the **power** key on the front panel.

You only need a simple optical 'Toslink' cable. Connect the Audionet Link output **Link OUT** [12] of your SAM 20 SE to the Audionet Link input of the unit to be controlled.

6 Usage

All functions of the SAM 20 SE are microprocessor controlled. This guarantees highest precision, exclusive functions, easy handling and protection against operating errors.

6.1 Powering up

First of all, please make sure your SAM 20 SE is connected correctly to mains power and to your signal sources (see section '*Installation and power supply*' on page 8 and '*Inputs and outputs*' on page 11).

The SAM 20 SE is a stand-by unit. Please operate the mains switch 10 on the back panel. The display shows a welcome message for a brief moment. After that the SAM 20 SE is in stand-by mode.

Only in cases of extended absence (like vacations) or if massive trouble on the mains power is to be expected (e.g. thunder storms) it is recommended to disconnect the SAM 20 SE from mains power. While the SAM 20 SE is in stand-by mode, operate mains switch 10 on the back panel. To disconnect the SAM 20 SE from mains power completely, you have to pull the mains power cord off the mains jack 9.



Important

- **Before you switch off the SAM 20 SE from mains, power down and discharge completely all units connected to the outputs of the SAM 20 SE.**

6.2 Switching on and off

To power up the SAM 20 SE from stand-by mode, press the **power** key on the front panel. The SAM 20 SE displays the message **Waking up..** After a short moment the unit is in normal operating mode and ready to use.

If you would like to switch off the unit, please press the **power** key on the front panel. The display shows the message **Going to sleep..** and unit enters the stand-by mode.



Note

- Of course, you may switch on/off the SAM 20 SE with the Audionet Metal Remote Control. For detailed information please refer to section '*Audionet Metal Remote Control*' on page 29.

6.3 Using Audionet Link

The SAM 20 SE is equipped with an Audionet Link output **Link OUT** 12 allowing you to switch on/off further Audionet units (e.g. power amplifiers or CD player) connected via Audionet Link (also see section '*Audionet Link*' on page 13).

If the rest of your Audionet system is connected to your SAM 20 SE via Audionet Link, all linked units will be automatically switched on/off as soon as you switch on/off your SAM 20 SE using the **power** key on the front panel or the key **SAM 20 SE** on the Audionet Metal Remote Control.



Note

- Please read section '*Audionet Link*' on page 13. Also, consult the user's manual of your Audionet components connected via Audionet Link for further information.
- If you switch off your Audionet chain using Audionet Link, it is important to wait until **all** devices are shut down before you restart the system.

6.4 Control elements on the front panel

The front panel has four keys to control the SAM 20 SE (see section '*Overview front panel*' on page 7). With these keys you are able control all functions as well as all setup options to adjust the unit to your preferences (see section '*Setup menu*' on page 19).

power	Use key to switch on/off the unit (see section ' <i>Switching on and off</i> ' on page 14).
set	Press key shortly to get to the setup menu. Within a menu item, press key shortly to navigate to the subordinated menu or to confirm and save a selected menu option. Press key and hold it for longer than two seconds to step back to the higher-level menu or to dismiss a selected menu option without saving (see section ' <i>Setup menu</i> ' on page 19).
down	Press key to reduce volume, select previous input channel (see section ' <i>Input selection</i> ' on page 17) or change an option of the setup menu (see section ' <i>Setup menu</i> ' on page 19).
up	Press key to increase volume, select next input channel (see section ' <i>Input selection</i> ' on page 17) or change an option of the setup menu (see section ' <i>Setup menu</i> ' on page 19).

6.5 Volume control

While the SAM 20 SE is in normal operating mode use keys **up** and **down** on the front panel to adjust the volume. **up** increases, **down** decreases the volume.

The volume control of the SAM 20 SE runs in a range from **-80 dB** (very quiet) to **+0 dB** (very loud) relative to the level of the input signal.



Note

- Use keys **up** and **down** also to change an option from the setup menu (see section '*Setup menu*' on page 19) as well as to select an input channel (see section '*Input selection*' on page 17).

6.6 Display

In the normal operating mode the display provides the following information:

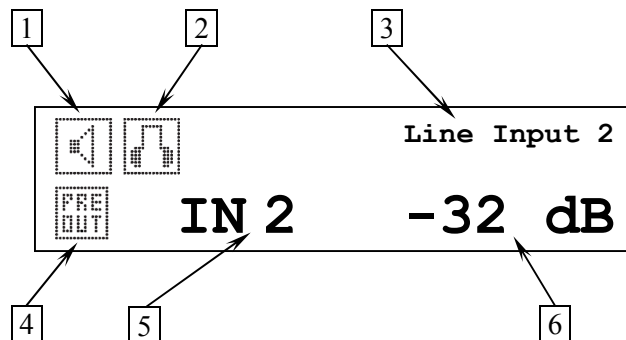

- 1 Status of the loudspeaker output mode (see section '*Headphones*' on page 21).
- 2 Status of the headphones output mode (see section '*Headphones*' on page 21).
- 3 Name of the currently selected input channel, fully user-definable (see section '*Channel Name*' on page 26).
- 4 Status of the preamplifier output mode (see section '*Pre Output*' on page 23).
- 5 Number of currently selected input channel, corresponds to the number printed above the input jack on the back panel (see section '*Overview back panel*' on page 8).
- 6 Current volume level in dB relative to the input level (see section '*Volume control*' on page 16).

As soon as you enter the setup menu by pushing the **set** key, the display changes to show information related to the selected menu item. For further details refer to the description of each menu item in section '*Setup menu*' starting from page 19.



Note

- After 10 minutes without any user interaction the 'display saver' is invoked automatically. The display then shows only the number of the currently selected input channel and the current volume level.

6.7 Input selection

Push the key **set** on the front panel for less than two seconds to enter the system menu. The first menu item is **Select Input**. Press key **set** again. Now select the desired input channel with the keys **up** and **down**. The last line of the display provides the number and the (user-definable) name of the currently selected input channel. Push **set** again to actually switch to the desired input channel.



Note

- Leave the input selection function by holding down the **set** key longer than 2 seconds.
- Using the Audionet Metal Remote Control, select an input channel by using the keys **CH+** and **CH-** to switch to the next or previous input channel without using the **Select Input** function.
- If you dedicated one of the input channels 1 to 5 to the By-Pass function (see section '*By-Pass Mode*' on page 24), this input channel is marked by '*' after the channel number in the display during input selection to remind you that switching to this input channel will activate the By-Pass Mode.

6.8 Muting



Note

- The mute function is only available on the Audionet Metal Remote Control.

Press key  on the Audionet Metal Remote Control to mute or un-mute your SAM 20 SE.

The display informs the user of a muted unit with the text **mute**. Even if the brightness level is set to **Off**, the text is displayed (see section 'Display' on page 22).

To un-mute the SAM 20 SE press key  again.



Note

- While the unit is muted, you may of course select a different input channel as described above. But the SAM 20 SE will stay muted until you press the key  again to un-mute and restore the original volume level.
- If you turn up the volume by using the key **up** or **VOL+**, while the SAM 20 SE is muted, the muting function will be deactivated and the new volume level set.

7 Setup menu

To adjust the SAM 20 SE to your preferences, please use the setup menu.

Push the key **set** on the front panel shortly to enter the setup menu. Push the key **set** again for less than two seconds to navigate to the subordinate menu, to enter the selected menu item or to acknowledge and save the currently selected setup option.



Hold down the key **set** for longer than 2 seconds to go back to the higher-level menu or dismiss the current menu option without saving

Press key **up** to move the menu item marker one step upwards or to change an option.

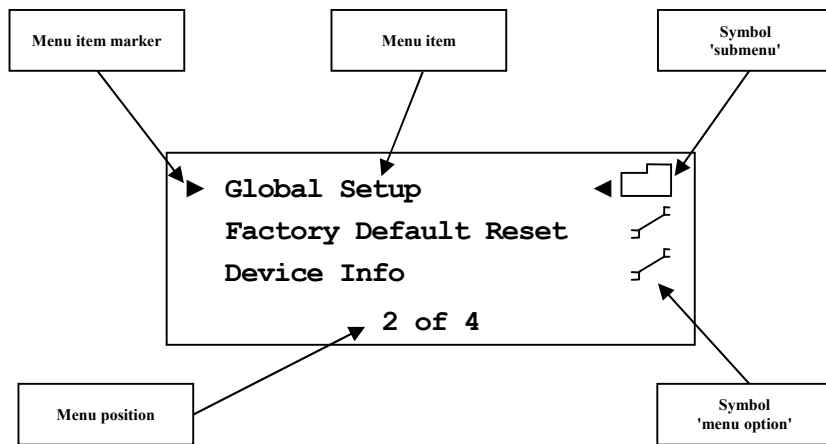
Press key **down** to move the menu item marker one step downwards to the previous menu item or to change an option.



The currently selected menu item is enclosed on the left and on the right by the menu item marker. Use keys **up** and **down** on the front panel to move the menu item marker to the desired menu item. To select a menu item press key **set** shortly.

To the right of each menu item a symbol denotes, if the item is a submenu  or a menu option . Navigate through any sub menu with the same keys as through the main menu.

If you opened a menu option, use the keys **up** and **down** to select the desired setting. Press key **set** shortly to confirm and save the selection. In case you would like to leave a (sub-)menu or dismiss a selected setting without saving, then hold down the key **set** for longer than 2 seconds. The SAM 20 SE will return to the higher-level menu.



Note

- If you make no adjustments for longer than 12 seconds the SAM 20 SE will automatically leave the setup menu and return to normal operating mode.

- While you are in the setup menu the display brightness is set to 100% for better readability. After leaving the setup menu the display brightness is automatically reset to its user selected level.
- If you power down the SAM 20 SE to stand-by mode all settings are stored automatically in the non-volatile memory of the unit. Even after disconnecting from mains power the SAM 20 SE will still remember your settings.

In the following all options of the setup menu are explained in detail.

7.1 Overview setup menu

The setup menu of the SAM 20 SE consists of four menu items. The menu item **Global Setup** is a sub menu containing 6 further setup options. The following table give an overview of the whole menu structure.

Select Input	Select the desired input channel
Global Setup	Main setup menu
Headphones	Headphones mode
Display	Adjust display brightness
Pre Output	Switch preamplifier output on/off
AutoStart	Setup automatic start-up mode
By-Pass Channel	Select input channel for By-Pass mode
Channel Name	Edit name of input channel (max. 14 characters)
Factory Default Reset	Reset device to factory defaults
Device Info	Get information on device

7.2 Select Input



Please refer to section "*Input selection*" on page 17.

7.3 Global Setup

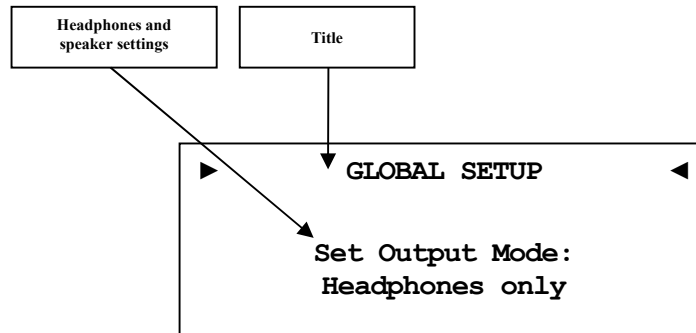

7.3.1 Headphones





Use the keys **up** and **down** to select the desired output configuration.

The two symbols  and  in the display indicate if the speakers and/or the headphones output is activated.



Speakers only

The headphones output **PHONES**  is disabled. The music signal is only available on the speaker terminals  and .

Headphones only

Only the headphones output **PHONES**  is active. The speaker outputs  and  are disabled.

Speakers & Headphones

The headphones output **PHONES**  and the speaker outputs  and  are active.



Note

- If the option **Headphones only** is selected, the pre amplifier output **PRE OUT**  will be automatically disabled.

7.3.2 Display

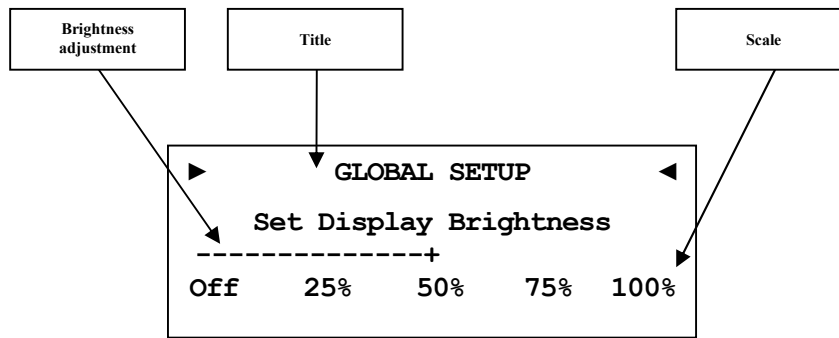

Use keys **up** and **down** to select the desired brightness of the display. Key **up** increases, key **down** decreases the brightness.



Important

- **Long-term usage of the display set to maximum brightness (setting 100%) may cause extended signs of wear resulting in a decay of contrast or brightness of individual dots in the display. Do not use the display with a brightness set higher than the factory default of 50% over a longer period of time!**



Note

- Is the brightness set to **Off** the display is only on during setup or volume adjustments. It switches off automatically several seconds after the last user entry.
- The SAM 20 SE activates the 'display saver' automatically after 10 minutes without any user entry.
- During active 'display saver', the display shows only the number of the selected input channel and current volume level in the form of **In 4 -47dB**. The display brightness is always reduced to 25%, and the location of the information text will change randomly every 12 seconds to prevent any 'burn-in' effect of the display.
- The 'display saver' is de-activated and the display returns to its normal mode as soon as any user entry is detected.
- The user cannot switch off the automatic 'display saver' function!

7.3.3 Pre Output

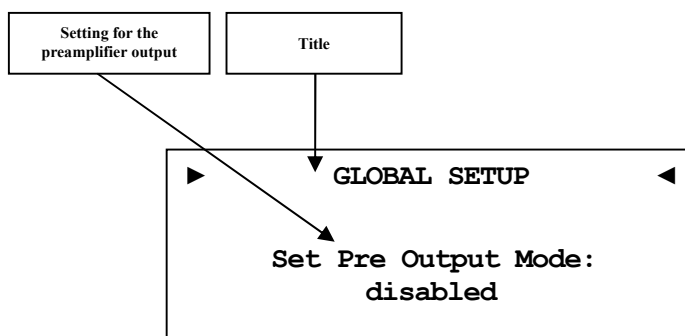

Press keys **up** on the front panel to activate the preamplifier output **PRE OUT** [16]. If you like to disable the preamplifier output press key **down**.



Note

- The display symbol  shows if the preamplifier output is activated.
- If the option **Headphones only** is selected, the pre amplifier output **PRE OUT** [16] will be automatically disabled.

7.3.4 AutoStart

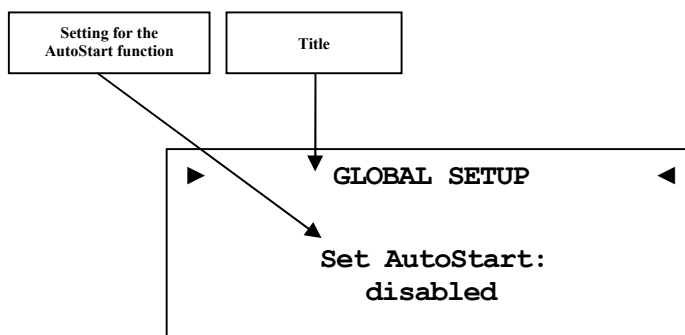

Press the key **up** on the front panel to activate the AutoStart function. If you like to disable the AutoStart function press the key **down**.

disabled The AutoStart function is disabled. After switching on the mains power switch [10] on the back panel, the SAM 20 SE enters the stand-by mode. You have to use the **power** key on the front panel or key **SAM 20 SE** on the Audionet Metal Remote Control to switch on the unit into normal operating mode.

active The AutoStart function is active. As soon as you connect the SAM 20 SE to mains (i.e. use the mains switch 10 on the back panel) the unit starts up automatically to normal operating mode. Use this setting for timer controlled operations.

7.3.5 By-Pass Mode

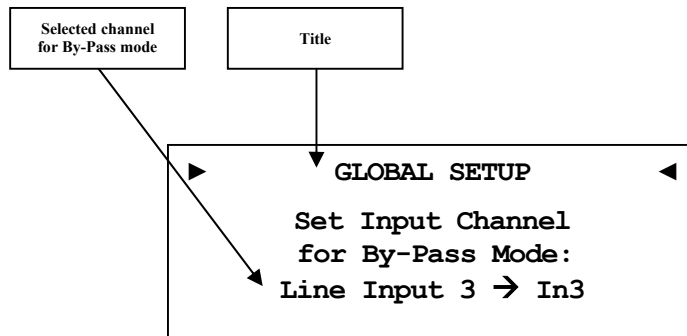

Use keys **up** and **down** on the front panel to select the input channel you would like to use in By-Pass Mode.



Important

- Before you are able to use the By-Pass Mode you first have to select which of the input channels is dedicated to the By-Pass Mode.
- For security reasons no input channel is selected for By-Pass Mode by factory default (**By-Pass Mode disabled**).
- Input 6 ('**Phono Input**') cannot be selected as input for the By-Pass Mode.

The By-Pass Mode is primarily intended to integrate the overwhelming sound quality of the SAM 20 SE into an existing home cinema setup or expand an existing excellent stereophonic system based on the SAM 20 SE to a complete home cinema setup without missing out on the qualities of the SAM 20 SE. To realize this kind of setup, please proceed as follows:

1. Connect you home cinema preamplifier according to its user's manual.
2. Connect the output for the front channels **Left** and **Right** not to the power amplifier but to one of the free inputs (except input 6 '**Phono Input**') of the SAM 20 SE.
3. Use menu item **By-Pass Channel** of the setup menu of the SAM 20 SE to select the input channel for By-Pass Mode you connected the outputs **Left** and **Right** of the home cinema preamplifier to.

4. Connect all high quality 2-channel sources to the remaining inputs of the SAM 20 SE.
5. Connect your DVD player to your home cinema preamplifier as usual.

Use the SAM 20 SE to listen to high quality 2-channel sources. If you would like to use your home cinema system activate the By-Pass Mode of the SAM 20 SE and use your home cinema preamplifier as usual.



Important

- **Please read this complete section about the special function By-Pass Mode first before you use this function in order to prevent incorrect usage and possible damage to your audio system and/or hearing.**
- **By factory default no input channel is selected for the By-Pass Mode. Use this menu item to select the desired input channel for the By-Pass Mode.**

While the By-Pass Mode is active the volume control of the SAM 20 SE is by-passed. The SAM 20 SE passes through the input signal to the outputs and amplifiers with its **full** level.

The special function By-Pass Mode of your SAM 20 SE is activated automatically if you switch to the input channel dedicated for By-Pass Mode in the setup menu item **By-Pass Channel**. The signal at the input channel selected for By-Pass Mode operations is passed through to the amplifiers and outputs of your SAM 20 SE at level of 0 dB (i.e. no change in volume level).

As soon as you select a different input channel, the special function By-Pass Mode is switched off automatically. The volume is reset to the prior level.



Important

- **Please check the correct connection and setup before you use the By-Pass Mode for the first time. The input signal will be passed through to the outputs and amplifiers at full level!**

As soon as the By-Pass Mode is activated, the SAM 20 SE will ignore all control commands coming from the keys on the front panel or the remote control (exceptions see below!).



Important

There are only two possibilities to disable the By-Pass Mode:

1. Select a different input channel. The SAM 20 SE switches to the newly selected input channel, resetting the volume to its prior level.

2. Push the **power** key on the front panel or the **SAM 20 SE** key on the Audionet Metal Remote Control. The SAM 20 SE switches to stand-by mode.



Note

- If you leave the By-Pass Mode by pushing the **power** key on the front panel or **SAM 20 SE** key on the Audionet Metal Remote Control, this mode will be saved, i.e. if you switch on the SAM 20 SE, the unit will switch to the last saved input channel selection and thus into By-Pass Mode.

7.3.6 Channel Name

You may assign a fully user-definable name up to 14 characters in length to each of the six input channels. If you select the menu item **Channel Name** of the Global Setup menu, the display will show the number of the currently selected input channel and the assigned channel name. The cursor in the display marks the character you now may alter.

Use the keys **up** and **down** on the front panel to select the desired character. Press key **set** for less than two seconds to move the cursor one step to the right. After the last position the cursor wraps around and starts at the first position again. In order to save the edited name and leave the menu item, press and hold the key **set** for longer than two seconds.



Tip

- To leave the menu item **Channel Name** without saving any changes you made just wait for 12 seconds. The SAM 20 SE will automatically get back to the normal display mode.

7.4 Factory Default Reset

Use menu item **Factory Default Reset** to reset all settings of your SAM 20 SE to their factory defaults.

Open the setup menu and navigate to item **Factory Default Reset** and press key **set**. The display prompts you to acknowledge the reset process.

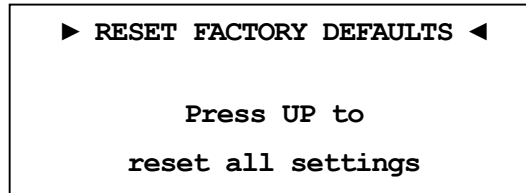

Press key **up** to confirm and reset all settings to the factory defaults.

Press key **set** to abort and return to the setup menu.

7.4.1 Overview factory default settings

Option	Setting
Select Input	Line Input 2 <- IN 2
Headphones	Speakers only
Display	50%
Pre Output	disabled
AutoStart	disabled
By-Pass Channel	By-Pass Mode disabled
Channel Name	1: Balanced In 2: Line Input 2 3: Line Input 3 4: Line Input 4 5: Tape Input 6: Phono Input

7.5 Device Info

```
▶           Device Info           ◀  
Device   : SAM 20 SE           ID:N  
Firmware: 04.0B
```

The menu item **Device Info** provides information on the device name and the installed firmware version.

8 Audionet Metal Remote Control

The included Audionet Metal Remote Control controls all the important function of everyday use of your SAM 20 SE. The following explains all these commands in detail.

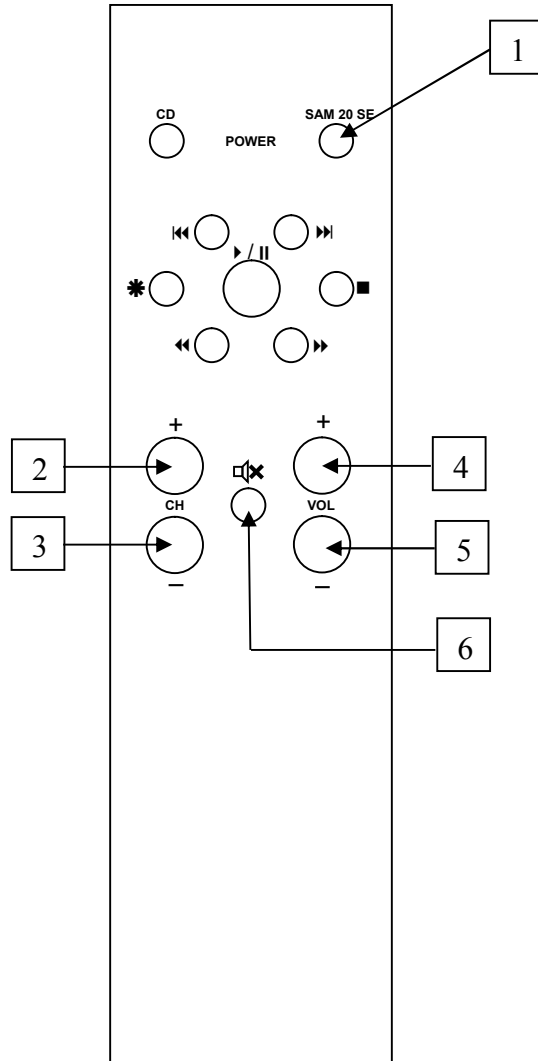

8.1 Key assignment SAM 20 SE

1 Power key **SAM 20 SE**

use the key **SAM 20 SE** to switch on / off your SAM 20 SE. This key has the same function as key **power** on the front panel. If the SAM 20 SE is in stand-by mode, press key **SAM 20 SE** to switch on this unit. If the SAM 20 SE is already switched on, then pressing **SAM 20 SE** powers the unit down to stand-by mode.

2 Key **CH +**

selects the next input channel of the SAM 20 SE.

3 Key **CH -**

selects the previous input channel of the SAM 20 SE.

4 Key **VOL +**

increases the volume of the SAM 20 SE.

5 Key **VOL -**

decreases the volume of the SAM 20 SE.

6 Mute key

mutes the SAM 20 SE. Press again to resume last volume level.

8.2 Changing the batteries

In order to exchange the batteries of your Audionet Metal Remote Control, first you have to remove the 6 Allen key screws on the bottom side.

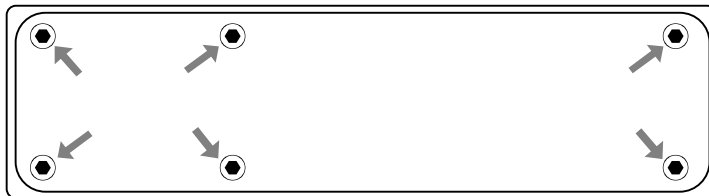

The battery compartment is to the left side of the circuit board. You need 2 batteries type 'AAA' or 'Micro' with a voltage of 1.5V.

Battery compartment





Important

- While inserting the batteries please mind their orientation. The correct orientation is printed onto the bottom of the battery compartment.

8.3 Settings for Audionet preamplifier

The Audionet Metal Remote Control has 6 keys to control an Audionet (pre-) amplifier like the SAM 20 SE. The previous section '*Key assignment SAM 20 SE*' explains the function of these keys.

Depending on their type, Audionet (pre-) amplifiers use different system addresses for their remote control code. A DIP switch on the circuit board of the Audionet Metal Remote Control selects the desired system address.

In order to set the system address you first have to open up the remote control (see section '*Changing the batteries*' on page 30).

For the Audionet Metal Remote Control the DIP switch for selecting the system address is located here:

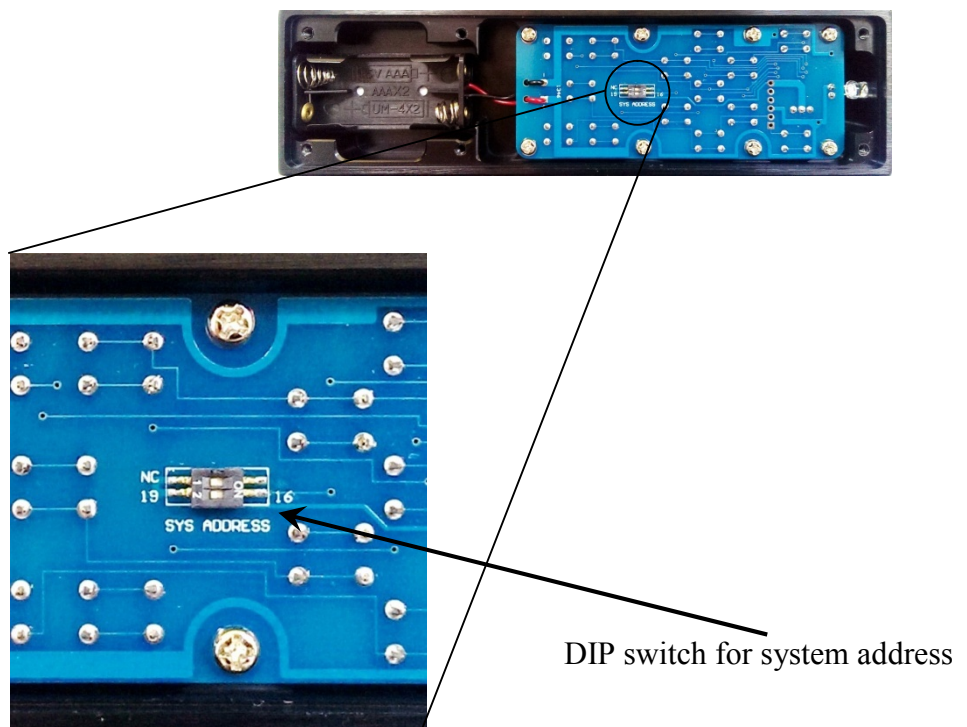

Put the DIP switch labelled 'SYS ADDRESS' in position '19' or '16' according to the following table:

Audionet preamplifier	Address
STERN, PRE G2, PRE 1 G3, SAM 20 SE , SAM G2 DNA, DNP, DNA 1	19
MAP 1	16



Note

- If not ordered explicitly, the Audionet Metal Remote Control is pre-configured to setting '19' of the DIP switch.
- Older models of Audionet preamplifiers use system address 16.

9 Protection system

Your Audionet SAM 20 SE and your loudspeakers are protected by a complex protection circuitry. In case of a malfunction the display informs the user about the nature of the detected error in plain text:

Error message	Possible cause
Overload	short circuit or defective speaker
Overheating	ventilation slots covered
High Frequency	defective pre amplifier-stage
DC Voltage	exceeding DC level at the output: defective pre amplifier-stage or source unit
Power Failure	(temporary) breakdown of mains power

Even after powering down the SAM 20 SE, the error message will still be in the display. Press the key **power** on the front panel to return to stand-by mode.



Important

- Remove cause of error prior to switching on the SAM 20 SE again!

10 Phono module

The SAM 20 SE comes with a fix installed phono module. Input 6 [6] is connected to the phono module. Please connect your turn table as described in section '*Phono*' on page 13.

10.1 Setup

Please make sure which type of pickup unit you have and which input impedance and gain is recommended by the manufacturer. You need this information to adjust the phono module optimally to the pickup. In case of doubt treat the pickup as 'MM' system and use the standard settings listed below.

Section '*Fine tuning*' on page 37 offers more detailed information on further adjustments.

The following picture shows the configuration elements of the phono module:

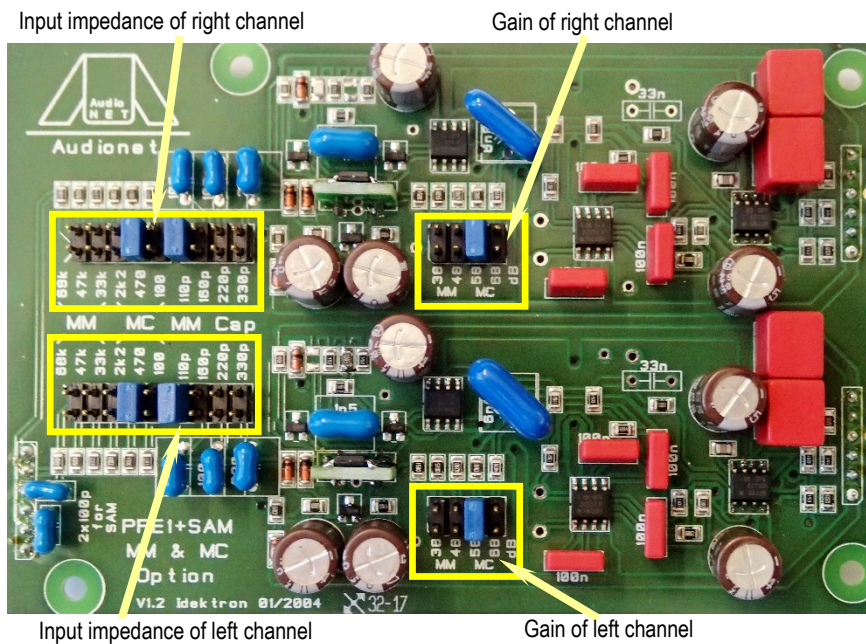

For each channel several jumper fields are available for setting up input impedance and gain.



Important

- Always select the same settings for input impedance and gain on both channels!

10.2 Jumper settings

The jumper fields in center of the module determine the gain. Please refer to the table below to find the jumper setting for the desired gain. Additionally, the gain is printed on the board right beside the jumper position.

The jumper field for selecting the input impedance is divided into two separate areas. The first five jumper positions (counted from the left) are for selecting the input resistance; the remaining four positions determine the input capacitance.

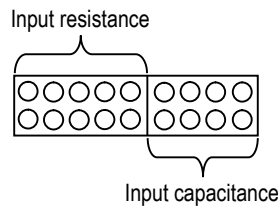

Again, the values are printed on the board right beside the jumper positions. To setup 68 k Ω input resistance please remove the corresponding jumper.

The following table lists all possible position and the corresponding values:

Input resistance	Input capacitance	Gain
68 k Ω	110 pF	38 dB
47 k Ω	160 pF	48 dB
33 k Ω	220 pF	58 dB
2,2 k Ω	330 pF	68 dB
470 Ω		
100 Ω		

10.3 MM pickup systems

For MM pickup systems set the gain to 38 dB, i.e. put the jumper in the left position (labelled '38' on the board, also see table above). For the settings of input resistance and capacitance please refer to the recommendations of the manufacturer of your pickup.

In case you have no recommendations from the manufacturer for input resistance and capacitance, set the jumpers to position 47 k Ω and 220 pF. These settings offer suitable conditions for most MM pickup systems.

10.4 MC pickup systems

MC pickup systems cover a great range of different output levels. To achieve an output matching the level of your other sources, the Audionet phono module offers three gain settings:

For pickups with a 'normal' output level (approx. 1..2 mV output voltage) set the 'gain' jumper to position 58 dB. For high output pickups (3..5 mV) position 48 dB is better suited. In case you have a low output pickup (<0.8 mV) set the gain to 68 dB. In case of doubt assume your pickup is working at a 'normal' output level.

For MC pickup systems the jumper for the input capacitance should be set to 110 pF. Select the input resistance recommended by the manufacturer or, if the information is not available, select position 100 Ω .

10.5 Typical setups

The following table outlines typical setups for miscellaneous pickup systems:

System	Output voltage	Gain	Input resistance	Input capacitance
Low Output MC	< 0,6 mV	68 dB	100 Ω	110 pF
MC	~ 1..2 mV	58 dB	100..470 Ω	110 pF
High Output MC	~ 3..5 mV	48 dB	100..470 Ω	110 pF
MM	~ 4..6 mV	48 dB	47..68 k Ω	160..220 pF
High Output MM	> 6 mV	38 dB	47..68 k Ω	160..220 pF



Important

- For optimum adjustment to your pickup follow the recommendations of the manufacturer! If necessary ask your dealer.

10.6 Fine tuning

After your first experiences with your new phono module some fine tuning might be possible to further improve the system.



Important

- **Unauthorised opening of an Audionet unit voids warranty!**
- **Disconnect the SAM 20 SE from mains power and pull the mains power cord before opening the device.**
- **Switch off the SAM 20 SE prior to changing the configuration of the phono module (= set jumper to a different position)! Otherwise your SAM 20 SE and/or speakers could suffer damage!**

To increase or decrease the output level of the phono module use the jumper field in the center of the module. The numbers 38..68 printed besides the jumper field represent the gain in dB.



Important

- Excessive gain could lead to overdrive and distortion!

Set the gain so that the output voltage of the phono module U_{modul} is approx. 1..1.5 V. With a given pickup voltage U_{pickup} the gain calculates to:

$$\frac{U_{\text{modul}}}{U_{\text{pickup}}} = \text{gain}.$$

Refer to the following table to get the gain in dB from the calculated gain factor in order to setup the jumper:

Gain in dB	38	48	58	68
Gain factor	80	250	800	2500

Example:

Output voltage: $U_{\text{modul}} = 1.2 \text{ V}$

Pickup voltage: $U_{\text{pickup}} = 1.5 \text{ mV}$

Gain: $\frac{1.2V}{1.5mV} = 800 \Rightarrow$ set phono module to 58 dB

If you are using a MM pickup system, adjust the high frequency range: Increase the input resistance (e.g. from 47 k Ω to 68 k Ω) to boost the high frequency range. Decrease the input resistance (e.g. from 47 k Ω to 33 k Ω) attenuates the high frequencies.

While selecting the input capacitance please keep in mind the capacitance of the connection cable from the analog drive to the SAM 20 SE (approx. 100 pF per meter of length). Exceeding capacitances most probably lead to presence boost and high frequency attenuation.

As described above, the input capacitance is extraneous for MC pickup systems. Some systems call for a higher input resistance (2.2 k Ω), others need a much lower setting (100 Ω) for optimum performance. Please follow the recommendations of the manufacturer of the pickup.

10.7 Factory defaults

The SAM 20 SE is set to the following factory default configuration:

Gain	58 dB
Input resistance	470 Ω
Input capacitance	110 pF

This configuration is suitable for most MC pickup systems.



Tip

- While you order the SAM 20 SE let your dealer know which pick-up system you are using. Thus, the SAM 20 SE can be configured to your required settings in the factory.

11 Security advice



Important

- Avoid packaging material, especially plastic bags, coming into children's hands!
- Store and operate the unit in a dry room at a reasonable room temperature only!
- Avoid moisture, any liquids, dirt or small objects getting into the unit!
- Set up the unit in a sufficiently ventilated environment!
- Do not cover the unit!
- Do not open the unit. Unauthorised opening will void warranty!
- Do not short-circuit the outputs!
- During connecting or removing the SAM 20 SE to/from sources and/or power/pre amplifiers all units have to be switched off to prevent damage of the SAM 20 SE or any of the other connected units.
- Use dry cloth for cleaning!

We would like to wish you many exciting listening experiences with your new Audionet product.

If you still have any questions, do not hesitate to ask your Audionet dealer or contact us directly

12 Technical data

Type	Analog integrated stereo amplifier
Output power	2 x 110 W into 8 Ω 2 x 200 W into 4 Ω
Frequency response	0 - 500,000 Hz (-3 dB)
Damping factor	> 1000 at 100 Hz
Harmonic distortion	k2 typ. -101 dB, k3 typ. -106 dB, @1 kHz, 25 W/4 Ω
THD+N	< -100 dB @1 kHz, 25 W/4 Ω
SNR	> 103 dB (A-weighted)
Channel separation	> 93 dB @ 1 kHz
Filtering capacitance	120,000 μ F
Inputs	5 pairs RCA line, gold plated, Teflon insulated 1 pair XLR balanced, gold plated (Neutrik)
Input impedance	Line input 10 k Ω , 10 pF XLR input 3 k Ω , 170 pF
Outputs	2 pair Furutech 4 mm jacks, Rhodium 1 pair RCA, gold-plated, Teflon insulated (Pre Out) 1 pair RCA, gold-plated, Teflon insulated (Rec Out) 1 Audionet Link, optical (TosLink) 1 6.3 mm socket for headphones (stereo)
Mains	220 V..240 V or 110..120 V, 50..60 Hz
Power consumption	< 1 W Stand-by, max. 700 W
Dimensions	Width 430 mm Height 110 mm Depth 360 mm
Weight	14.5 kg
Finish	Front: brushed aluminium, 10 mm, black or silver anodized, text and symbols engraved Display: red or blue Cover: aluminium, 4 mm, black anodized Plates: aluminium, 8 mm, black anodized Chassis: sheet steel, black varnished

<p>Features</p>	<ul style="list-style-type: none"> • strictly limited edition • Audionet ULA technology (Ultra Linear Amplifier) • completely DC-coupled, no capacitors in the signal path • encapsulated toroid transformer with 700 VA • new audio-grade capacitors with 25% more filtering capacitance of 15,000 μF totalling 120,000 μF • new MOSFETs • onward optimized gold-doped, pure silver solid core signal cabling • By-Pass mode for home cinema integration • microprocessor with its own power supply controls and handles all functions • headphones output electronically switchable • remote activation of other Audionet components via Audionet Link (optical fibre) • included phono module with integrated OpAmps of highest quality and FET inputs as well as optimized mica capacitors • engraved front panel and new back panel • dedicated SAM 20 SE Audionet metal remote control
------------------------	--

Errors and omissions excepted. Specifications and design are subject to changes without prior notice

AUDIONET is a trademark of Idektron GmbH & Co KG

Engineered and produced by:
Idektron GmbH & Co. KG, Alboinstraße 36 - 42, 12103 Berlin, Germany
www.audionet.de
contact@audionet.de