

Audionet

SAM G2

Stereo Amplifier

User's Manual

Contents

1	Preface	5
1.1	Included.....	6
1.2	Transport.....	6
2	Overview front panel	7
3	Overview back panel	8
4	Installation and power supply	9
4.1	Placement	9
4.2	Mains connection	9
4.3	Orientation of mains plug	10
5	Inputs and outputs	11
5.1	Inputs.....	11
5.2	Speaker terminals.....	11
5.3	Preamplifier Output.....	12
5.4	Recording devices	12
5.5	Phono	12
5.6	Headphones socket	13
5.7	Audionet Link.....	13
6	Usage	14
6.1	Powering up	14
6.2	Switching on and off.....	14
6.3	Mains phase detection	15
6.4	Using Audionet Link	15
6.5	Control elements on the front panel	16
6.6	Volume control.....	16
6.7	Display	17
6.8	Input selection.....	17
6.9	Muting	18
7	Setup menu	19
7.1	Set Output Mode.....	20
7.2	Set Display Brightness.....	20

7.3	Set Pre Output Mode	21
7.4	Set Autostart	21
7.5	Edit Channel Name	22
7.6	Set Channel for By-Pass Mode	22
7.7	Overview factory defaults	25
8	Audionet Metal Remote Control	26
8.1	Key assignment SAM G2	27
8.2	Changing the batteries	27
8.3	Settings for Audionet preamplifier	28
9	Protection system	30
10	Technical information	31
10.1	Design	31
10.2	Power Supply	31
10.3	Circuitry	31
10.4	Operation	31
11	Security advice	32
12	Technical data	33

1 Preface

The Audionet Team congratulates you on your purchase of this unit.

Audionet components are no marketing products, they are authentic. Conceived and developed with scientific inspiration, professional engineering expertise and a passion for achieving the perfect sound. They are unique creations designed to inspire musical enjoyment and have an excellent reputation amongst all connoisseurs throughout the world. Each and every one of our precision-manufactured devices is individually crafted at our Berlin works by our experienced and passionate workforce.

But before you start listening to your new Audionet SAM G2, please read this manual carefully so you are able to use and enjoy all functions of this unit without drawback on music quality.

1.1 Included

Included you will find the following items:

- the stereo integrated amplifier SAM G2
- the user's manual (that you are currently reading)
- one standard mains cord
- Audionet Metal Remote Control RC 1

1.2 Transport



Important

- Please transport the SAM G2 only in the included package.
- Always use the provided cloth bag to prevent scratches on the casing.
- Please allow the SAM G2 to adapt to the climatic conditions in your listening room before you switch on the unit for the first time after transport.

2 Overview front panel

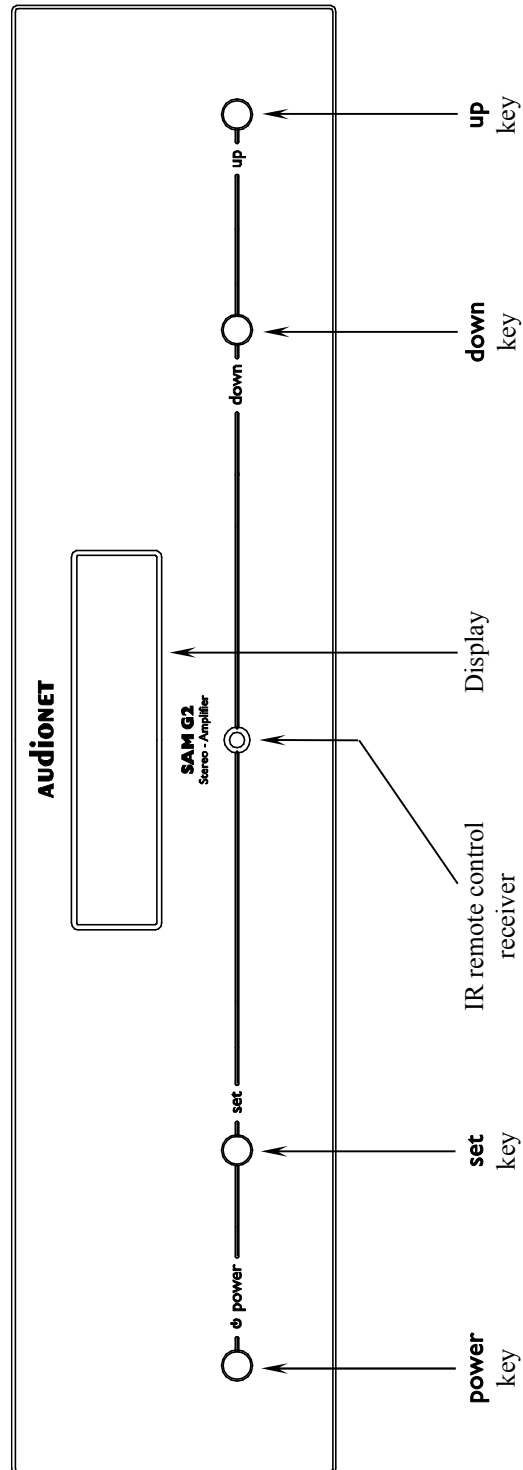

3 Overview back panel

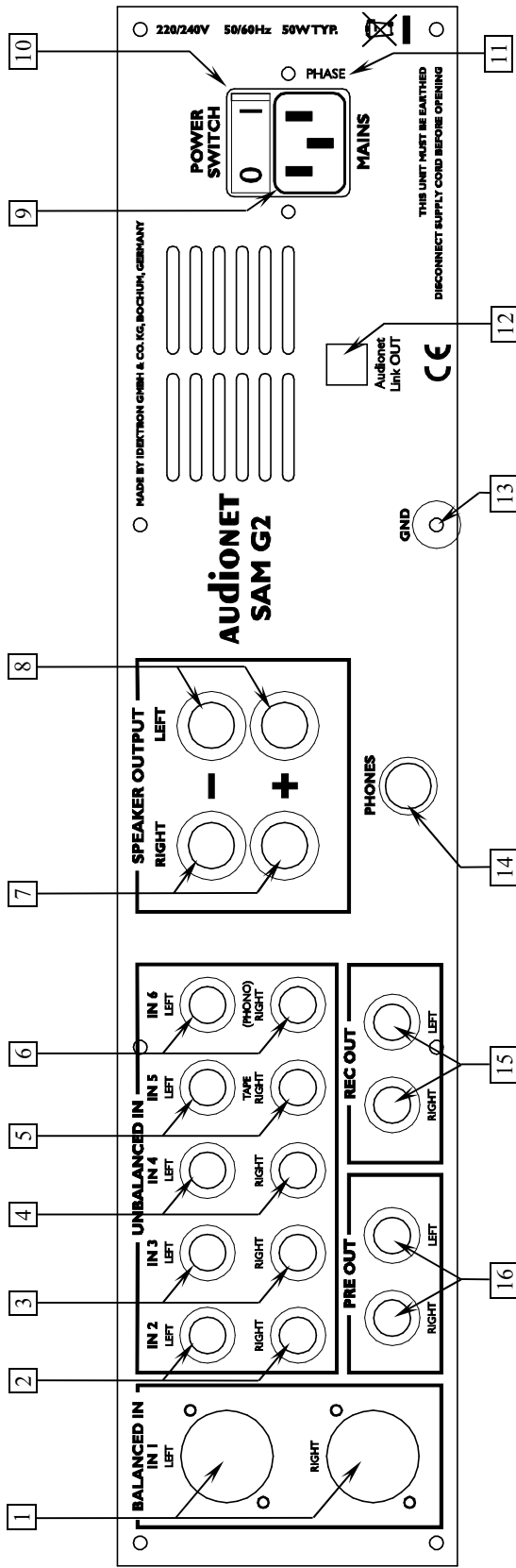

- 1 Balanced input (XLR) no. 1, left/right
- 2 RCA input no. 2, left/right
- 3 RCA input no. 3, left/right
- 4 RCA input no. 4, left/right
- 5 RCA input no. 5, left/right
- 6 RCA input no. 6, left/right
- 7 Speaker terminal, right channel
- 8 Speaker terminal, left channel
- 9 Mains input
- 10 Mains switch
- 11 Marking mains phase
- 12 Audionet Link output OUT
- 13 Earth connector for turntable
- 14 Headphones socket
- 15 Recording output **REC OUT**, left/right
- 16 Pre amplifier Output, **PRE OUT** left/right

4 Installation and power supply



Important

- During connecting and removing of sources or amplifiers to the SAM G2 all units of your audio system have to be switched off to prevent damage of the SAM G2 or any of the other connected units.
- Please make sure that all cables are in absolute best conditions! Broken shields or short-cut cables could damage the SAM G2 and/or any other connected unit.

4.1 Placement



Important

- It is recommended to place the SAM G2 into a high quality rack or onto a stable table.
- Do not expose the unit to direct sunlight.
- Do not cover the ventilation slots.
- Do not place the SAM G2 in close range to heat sources like radiators.
- Do not place the SAM G2 on top of other units, especially not on top of power amplifiers, pre amplifiers or similar that produce heat. Both units could suffer damage from thermal overload.
- Do not use the unit in places where it is exposed to vibrations.
- Do not place the unit close to loudspeakers or into the corner of a room where it is exposed to high levels of sonic energy, which might reduce the sound quality of the unit.

4.2 Mains connection

The mains input 9^{*} is on the back panel of the SAM G2. To connect the unit to mains use the included mains cord. If you prefer to use a different power cord make sure that it meets the specifications for your home country.



Important

- The electrical specifications of your home country must meet the electrical specifications printed onto the back panel.

* see numbers in section 'Overview back panel' on page 8.

- The SAM G2 is a Class I unit and must be earthed. Please ensure a stable earth connection. Phase ('hot' pin) is marked on the back panel ('phase') [11].
- If you connect the mains cord please make sure that mains switch [10] at the back panel is switched off.
- Never pull the mains plug while the SAM G2 is switched on! Before you pull the mains cord off its socket [9] at the back panel, power down the unit to stand-by mode and switch off the unit using mains switch [10].

Only in cases of extended absence – like vacations – or if massive trouble on the mains power is to be expected you should switch off the SAM G2 from the mains using the mains switch [10]. To disconnect the unit completely from mains pull the mains plug.



Tip

- The use of high quality mains cords (e.g. Audionet P10) could improve sound quality. Ask your local dealer for more information.

4.3 Orientation of mains plug

The correct polarization of mains is important for reasons of audio clarity and stability. Please connect the mains cord so that the hot pin of the wall outlet is connected to the pin of the mains input [11] marked 'PHASE' [9]. Your Audionet SAM G2 is able to detect a wrong polarization of the mains plug during start-up. If the message

▶ **Attention:** ◀
▶ **Mains phase incorrect** ◀

appears in the display, switch off the unit and flip the mains plug in the wall outlet (see section '*Mains phase detection*' on page 15).

5 Inputs and outputs



Important

- **During connecting and removing of sources or amplifiers to the SAM G2 all units of your audio system have to be switched off to prevent damage of the SAM G2 or any of the other connected units.**
- **Please make sure that all cables are in absolute best conditions! Broken shields or short-cut cables could damage the SAM G2 and/or any other connected unit.**

5.1 Inputs

The SAM G2 is equipped with five RCA inputs **2** to **6** and one balanced (XLR) input **1** for connecting signal sources at line level.

Please connect the left and right input of the same number printed on the back panel of the SAM G2 to the corresponding output of the source you would like to connect to the SAM G2.

5.2 Speaker terminals

Connect your speakers to the gold plated terminals **7** and **8** on the back panel of the SAM G2. You can use banana plugs or spades as well as simple cable ends. Look out for the correct connection of your speaker cables. Usually, the terminals of your speakers are marked '+' and '-'. The SAM G2 uses the same marks.



Note

- Wrong speaker polarization will result in severe loss of sound quality.
- In case you would like to bi-wire your speakers please insert the cable to the tweeters from the rear using banana plugs and mount the cables to the bass speakers from the side. In doubt please ask your dealer for assistance.



Important

- **Although the SAM G2 has an effective protection system to prevent damage to the circuits, switch off the unit while working on the speaker and/or audio cables.**

- The nominal loudspeaker impedance should be at least 4 Ohms or higher.
- Never use force or tools tightening the terminal screws.

5.3 Preamplifier Output

The SAM G2 is equipped with a pair of RCA preamplifier outputs to connect e.g. an additional amplifier or a subwoofer.

Please use high quality interconnectors to connect the **PRE OUT** [16] of your SAM G2 with an additional amplifier or subwoofer.

5.4 Recording devices

You can connect one recording device to the SAM G2 for recording and playback.

Connect your recording device (like DAT or tape recorder) to the recording output **REC OUT** [15] of the SAM G2. For playback please connect your recording device only to input no. 5 **IN 5** [5] of the SAM G2, if it is also connected to the output **REC OUT** [15] of your SAM G2. If you select input no. 5 **IN 5** [5] the output **REC OUT** [15] is switched off to prevent any feedback loops between your recording device and the SAM G2.

Please use inputs no. 1 [1] to no. 4 [4] and no. 6 [6] to connect sources you like to record from. With these inputs the recording output **REC OUT** [15] is always active.

5.5 Phono

The SAM G2 can be upgraded with a phono preamplifier board. In this case use the input no. 6 **IN 6** [6] marked as **PHONO** to connect your turntable to the SAM G2. Connect the earth wire of your turntable to the earth connector **GND** [13]. For further information on the optional phono preamplifier board please refer to its user's manual.



Important

- If the SAM G2 is upgraded with the optional phono module, input no. 6 **IN 6** [11] must only be used to connect a turntable.
- You cannot use input no. 6 **IN 6** [11] for By-Pass mode (see section 'Set Channel for By-Pass Mode' on page 22).

5.6 Headphones socket

A 6.3 mm headphones socket is located at the rear of your SAM G2. The signal at this socket can be switched on and off to allow the headphones to be plugged in permanently. Switching is easily done on the front panel, please refer to section '*Set Output Mode*' on page 20.

5.7 Audionet Link

For your convenience, the SAM G2 can switch on/off all other Audionet units (e.g. power amplifiers) connected via Audionet Link by a simple touch on the remote control or the **power** key on the front panel.

You only need a simple optical 'Toslink' cable. Connect the Audionet Link output **Link OUT** 12 of your SAM G2 to the Audionet Link input of the unit to be controlled.



6 Usage

All functions of the SAM G2 are microprocessor controlled. This guarantees highest precision, exclusive functions, easy handling and protection against operating errors.

6.1 Powering up

First of all, please make sure your SAM G2 is connected correctly to your signal sources and mains (see section '*Installation and power supply*' on page 8 and '*Inputs and outputs*' on page 11).

The SAM G2 is a stand-by unit. Please operate the mains switch  on the back panel. The display shows a welcome message for a brief moment. After that the SAM G2 is in stand-by mode.

Only in cases of extended absence (like vacations) or if massive trouble on the mains power is to be expected (e.g. thunder storms) it is recommended to disconnect the SAM G2 from the mains. While the SAM G2 is in stand-by mode, operate mains switch  on the back panel. To disconnect the SAM G2 from mains completely, you have to pull the mains cord off the mains jack .



Important

- **Before you switch off the SAM G2 from mains, power down and discharge completely all units connected to the outputs of the SAM G2.**

6.2 Switching on and off

To power up the SAM G2 from stand-by mode, press the **power** key on the front panel. The SAM G2 displays the message **Waking up...** In case the mains plug has the incorrect polarization a warning will appear in the display (see section '*Mains phase detection*' on page 15). After that the unit is in normal operating mode and ready to use.

If you would like to switch off the unit, please press the **power** key on the front panel. The display shows the message **Going to sleep..** and unit enters the stand-by mode.



Note

- Of course, you may switch on/off the SAM G2 with the Audionet Metal Remote Control *RC 1* or *RC 2*. For detailed information please refer to section '*Audionet Metal Remote Control*' on page 26.

6.3 Mains phase detection

The correct polarization of mains is important for reasons of audio clarity and stability. Please connect the mains cord that the 'hot' pin of the wall outlet is connected to the pin marked 'phase' [11] of the mains input [9] on the back panel. The SAM G2 recognizes the incorrect polarization of the mains plug automatically. Right after switching on the unit from stand-by mode by pressing the **power** key on the front panel the following message will appear in the display in case the mains polarization is incorrect:

▶ **Attention:** ◀
▶ **Mains phase incorrect** ◀

If you read the above message, switch off the unit by pressing the **power** key. Please wait until the display no longer reads **Going to sleep...** Disconnect the SAM G2 from mains by operating the mains switch [10]. Now pull the mains plug and re-insert it into the mains socket rotated by 180°.

If you switch on the unit again, the warning should not appear now.



Important

- If the SAM G2 issues the mains polarization warning or no warning at all for both positions of the mains plug, check the connection to earth of your mains socket and mains cord. **You have to ensure a stable connection to earth for the mains phase detection of the SAM G2 to work correctly!**

6.4 Using Audionet Link

The SAM G2 is equipped with an Audionet Link output **Link OUT** [12] allowing you to switch on/off further Audionet units (e.g. power amplifiers, CD player or tuner) connected via Audionet Link (also see section '*Audionet Link*' on page 13).

If the rest of your Audionet system is connected to your SAM G2 via Audionet Link, all linked units will be automatically switched on/off as soon as you switch on/off your SAM G2 using the **power** key on the front panel or the key **PRE** on the Audionet Metal Remote Control *RC 1* or *RC 2*.



Note

- Please read section '*Audionet Link*' on page 13. Also, consult the user's manual of your Audionet components connected via Audionet Link for further information.

- If you switch off your Audionet chain using Audionet Link, it is important to wait until **all** devices are shut down before you restart the system.

6.5 Control elements on the front panel

The front panel has four keys to control the SAM G2 (see section '*Overview front panel*' on page 7). With these keys you can control all functions as well as all setup options to adjust the unit to your preferences (see section '*Setup menu*' on page 19).

power	Use key to switch on/off the unit (see section ' <i>Switching on and off</i> ' on page 14).
set	Push key shortly to navigate through the setup menu. Keep key pushed for longer than two seconds to exit the setup menu (see section ' <i>Setup menu</i> ' on page 19).
down	Push key to reduce volume, select previous input channel (see section ' <i>Input selection</i> ' on page 17) or change an option of the setup menu (see section ' <i>Setup menu</i> ' on page 19).
up	Push key to increase volume, select next input channel (see section ' <i>Input selection</i> ' on page 17) or change an option of the setup menu (see section ' <i>Setup menu</i> ' on page 19).

6.6 Volume control

While the SAM G2 is in normal operating mode use keys **up** and **down** on the front panel to adjust the volume. **up** increases, **down** decreases the volume.

The volume control of the SAM G2 runs in a range from -80 dB to $+0$ dB relatively to the level of the input signal.



Note

- Use keys **up** and **down** also to change an option from the setup menu (see section '*Setup menu*' on page 19) as well as to select an input channel (see section '*Input selection*' on page 17).

6.7 Display

The display provides in the normal operating mode the following information:

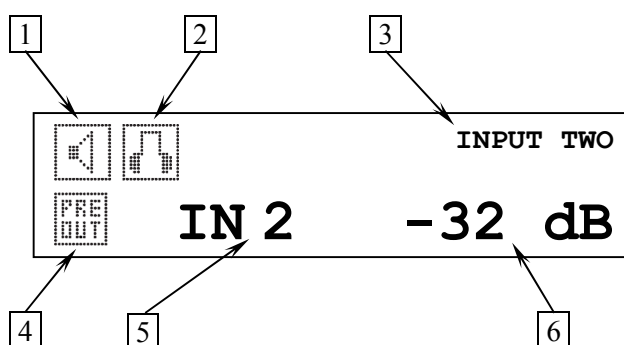

- 1 Status of the loudspeaker output mode (see section '*Set Output Mode*' on page 20).
- 2 Status of the headphones output mode (see section '*Set Output Mode*' on page 20).
- 3 Name of the currently selected input channel, fully user-definable (see section '*Edit Channel Name*' on page 22).
- 4 Status of the preamplifier output mode (see section '*Set Pre Output Mode*' on page 21).
- 5 Number of currently selected input channel, corresponds to the number printed above the input jack on the back panel (see section '*Overview back panel*' on page 8).
- 6 Current volume level in dB relative to the input level (see section '*Volume control*' on page 16).

As soon as you enter the setup menu by pushing the **set** key, the display changes to show information related to the selected menu item. For further display details refer to the description of each menu item in section '*Setup menu*' starting from page 19.



Note

- After 10 minutes without any user interaction the 'display saver' is invoked automatically. The display then shows only the number of the currently selected input channel and the current volume level.

6.8 Input selection

Push the **set** key on the front panel once for less than two seconds, then select the desired input channel with the keys **up** and **down**. The 2nd line of the display provides the number and the (user-definable) name of the

currently selected input channel. Push **set** again to actually switch to the desired input channel.



Note

- Leave the input selection function by holding down the **set** key longer than 2 seconds.
- Using the Audionet Metal Remote Control *RC 1* or *RC 2*, select an input channel by using the keys **CH+** and **CH-** to switch to the next or previous input channel without using the **Select Input** function.
- If you dedicated one of the input channels 1 to 5 to the By-Pass function (see section '*Set Channel for By-Pass Mode*' on page 22), this input channel is marked by '*' after the channel number in the display during input selection to remind you that switching to this input channel will activate the By-Pass Mode.

6.9 Muting



Note

- The mute function is only available on the Audionet Metal Remote Control *RC 1* or *RC 2*.

Press key  on the Audionet Metal Remote Control *RC 1* or *RC 2* to mute or un-mute your SAM G2.

The SAM G2 uses 'soft' muting, i.e. volume is stepped down gently to -80 dB. The display informs the user of a muted unit with the text **MUTE**. Even if the brightness level is set to **Off**, the text is displayed (see section '*Set Display Brightness*' on page 20).

To un-mute the SAM G2 press key  again. Here as well, the volume is stepped up gently to its original level after switching on the outputs.



Note

- While the unit is muted, you may of course select a different input channel as described above. But the SAM G2 will stay muted until you press the key  again to un-mute and restore the original volume level.
- If you turn up the volume by using the key **up** or **VOL+**, while the SAM G2 is muted, the muting function will be deactivated and the new volume level set.

7 Setup menu

To adjust the SAM G2 to your preferences, please use the setup menu.

Push the **set** key on the front panel longer than two seconds to go to the first item of the setup menu. Navigate to the next menu item, by pushing the **set** key again for less than two seconds. Below is a list of all menu items of the setup menu.

After the last menu item you will leave the setup menu automatically. Of course, you may leave the setup menu from each menu item by holding the **set** key down for longer than two seconds. The SAM G2 will return to the normal operating mode.

The order of items in the setup menu is:

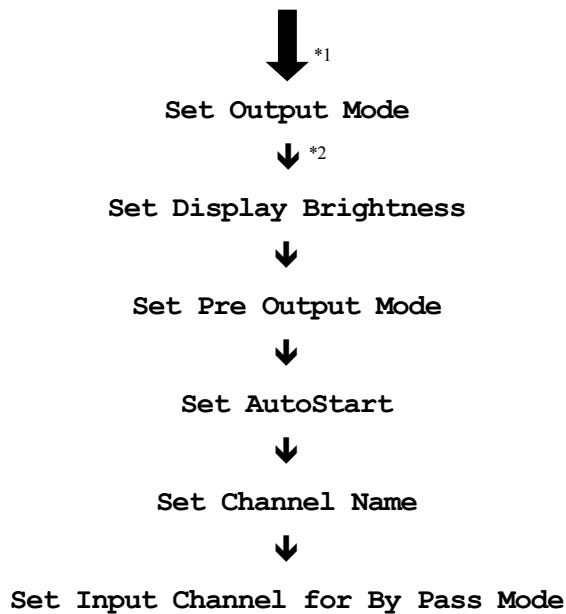

Change any setting of a menu item by using the keys **up** and **down** on the front panel.



Note

- If you make no adjustments for longer than 12 seconds the SAM G2 will automatically leave the setup menu and return to normal operating mode.
- While you are in the setup menu the display brightness is set to 100% for better readability. After leaving the setup menu the display brightness is automatically reset to its user selected level.

*1 to enter the setup menu push and hold **set** key longer than two seconds



*2 ↓ = push **set** key shortly (less than two seconds)







- If you power down the SAM G2 to stand-by mode all settings are stored automatically in the non-volatile memory of the unit. Even after disconnecting from mains the SAM G2 will still remember your settings.

In the following all options of the setup menu are explained in detail.

7.1 Set Output Mode

Push the **set** key on the front panel longer than two seconds to enter the setup menu and get to the menu item **Set Output Mode**. Now use the keys **up** and **down** to select the desired output configuration.

The two symbols  and  in the display show if the speaker and/or the headphones output is activated.

Speakers only	The headphones output PHONES  is disabled.
Headphones only	Only the headphones output PHONES  is active. The speaker outputs  and  are disabled.
Speakers & Headphones	The headphones output PHONES  and the speaker outputs  and  are active.



Note

- If the option **Headphones only** is selected, the pre amplifier output **PRE OUT**  will be automatically disabled.

7.2 Set Display Brightness

To adjust the brightness of the display on the front panel of the SAM G2 push and hold the **set** key longer than 2 seconds to enter the setup menu. Then push the **set** key once for less than two seconds to get to menu item **Set Display Brightness**. Now use keys **up** and **down** to select the desired brightness. Key **up** increases, key **down** decreases the brightness.



Important

- **Long-term usage of the display set to maximum brightness (setting 100%) may cause extended signs of wear resulting in a decay of contrast or brightness of individual dots in the display. Do not**

use the display with a brightness set higher than the factory default of 50% over a longer period of time!



Note

- Is the brightness set to **Off** the display is only on during setup or volume adjustments. It switches off automatically several seconds after the last user entry.
- The SAM G2 activates the 'display saver' automatically after 10 minutes without any user entry.
- During active 'display saver', the display shows only the number of the selected input channel and current volume level in the form of **In 4 -47dB**. The display brightness is always reduced to 25%, and the location of the information text will change randomly every 12 seconds to prevent any 'burn-in' effect of the display.
- The 'display saver' is de-activated and the display returns to its normal mode as soon as any user entry is detected.
- The user cannot switch off the automatic 'display saver' function!

7.3 Set Pre Output Mode

Push and hold the **set** key on the front panel longer than 2 seconds to enter the setup menu. Then push the **set** key twice for less than 2 seconds to set get to menu item **Set Pre Output Mode**. Now use the keys **up** and **down** to activate or disable the preamplifier output **PRE OUT** 7.



Note

- The display symbol PRE
OUT shows if the preamplifier output is activated.
- If the option **Headphones only** is selected, the pre amplifier output **PRE OUT** 7 will be automatically disabled.

7.4 Set Autostart

Push and hold the **set** key longer than 2 seconds to enter the setup menu. Then push the **set** key three times for less than two seconds to get to the menu item **Set Autostart**. Push the **up** key on the front panel to activate the Autostart function. If you like to deactivate the Autostart function push the **down** key.

disabled The Autostart function is disabled. After switching on the mains switch 10 on the back panel, the SAM G2 enters

the stand-by mode. You have to use the **power** key on the front panel or key **PRE** on the Audionet Metal Remote Control *RC 1* or *RC 2* to switch on the unit into normal operating mode.

active The Autostart function is active. As soon as you connect the SAM G2 to mains (i.e. use the mains switch **10** on the back panel) the unit starts up automatically to normal operating mode. Use this setting for timer controlled operations.

7.5 Edit Channel Name

Press and hold the **set** key for longer than 2 seconds to enter the setup menu. Then push the **set** key four times to get to the menu item **Edit Channel Name**.

You can assign a fully user-definable name up to 14 characters in length to each of the six input channels. The display will show the number of the currently selected input channel and the assigned channel name. The cursor in the display marks the character you now may alter.

Use the keys **up** and **down** on the front panel to select the desired character. Hold **set** key down for longer than two seconds to move the cursor one step to the right. After the last position the cursor wraps around and starts at the first position again.



Note

- To leave the menu item Edit Channel Name just wait for 12 seconds. The SAM G2 will automatically get back to the normal display mode. Alternatively, you push the **set** key for less than 2 seconds to get to the next menu item and leave then by holding the **set** key for longer than 2 seconds.

7.6 Set Channel for By-Pass Mode

Push and hold the **set** key for longer than 2 seconds to enter the setup menu. Then push the **set** key five times for less than two seconds to enter the menu item **Set Channel for By-Pass Mode**.

Use keys **up** and **down** on the front panel to select the input channel you would like to use in By-Pass Mode.



Important

- Before you are able to use the By-Pass Mode you first have to select which of the input channels is dedicated to the By-Pass Mode.

- For security reasons no input channel is selected for By-Pass Mode by factory default (**By-Pass Mode disabled**).
- Input 6 ('**PHONO INPUT**') cannot be selected as input for the By-Pass Mode.

The By-Pass Mode is primarily intended to integrate the overwhelming sound quality of the SAM G2 into an existing home cinema setup or expand an existing excellent stereophonic system based on the SAM G2 to a complete home cinema setup without missing out on the qualities of the SAM G2. To realize this kind of setup, please proceed as follows:

1. Connect your home cinema preamplifier according to its user's manual.
2. Connect the output for the front channels Left and Right not to the power amplifier but to one of the free inputs (except input 6 '**PHONO INPUT**') of the SAM G2.
3. Use menu item **Set Channel for By-Pass Mode** of the setup menu of the SAM G2 to select the input channel for By-Pass Mode you connected the outputs Left and Right of the home cinema preamplifier to.
4. Connect all high quality 2-channel sources to the remaining inputs of the SAM G2.
5. Connect your DVD player to your home cinema preamplifier as usual.

Use the SAM G2 to listen to high quality 2-channel sources. If you would like to use your home cinema system activate the By-Pass Mode of the SAM G2 and use your home cinema preamplifier as usual.



Important

- **Please read this complete section about the special function By-Pass Mode first before you use this function in order to prevent incorrect usage and possible damage to your audio system and/or hearing.**
- **By factory default no input channel is selected for the By-Pass Mode. Use this menu item to select the desired input channel for the By-Pass Mode.**

While the By-Pass Mode is active the volume control of the SAM G2 is by-passed. The SAM G2 passes through the input signal to the outputs and amplifiers with its **full** level.

The special function By-Pass Mode of your SAM G2 is activated automatically if you switch to the input channel dedicated for By-Pass Mode in the setup menu item **Set Channel for By-Pass Mode**. The signal at the input channel selected for By-Pass Mode operations is passed through to the amplifiers and outputs of your SAM G2 at level of 0 dB (i.e. no change in volume level).

As soon as you select a different input channel, the special function By-Pass Mode is switched off automatically. The volume is reset to the prior level.



Important

- **Please check the correct connection and setup before you use the By-Pass Mode for the first time. The input signal will be passed through to the outputs and amplifiers at full level!**

As soon as the By-Pass Mode is activated, the SAM G2 will ignore all control commands coming from the keys on the front panel or the remote control (exceptions see below!).



Important

There are only two possibilities to disable the By-Pass Mode:

1. Select a different input channel. The SAM G2 switches to the newly selected input channel, resetting the volume to its prior level.
2. Push the **power** key on the front panel or the **PRE** key on the Audionet Metal Remote Control *RC 1* or *RC 2*. The SAM G2 switches to stand-by mode.



Note

- If you leave the By-Pass Mode by pushing the **power** key on the front panel or **PRE** key on the Audionet Metal Remote Control *RC 1* or *RC 2*, this mode will be saved, i.e. if you switch on the SAM G2, the unit will switch to the last saved input channel selection and thus into By-Pass Mode.

7.7 Overview factory defaults

Option	Setting
Select Input	INPUT TWO -> IN 2
Set Output Mode	Speakers only
Set Display Brightness	50%
Set Pre Output Mode	disabled
Set AutoStart	disabled
Channel name	1: BALANCED IN 2: INPUT TWO 3: INPUT THREE 4: INPUT FOUR 5: TAPE INPUT 6: PHONO INPUT
Set Input Channel for By Pass Mode	By-Pass Mode disabled

8 Audionet Metal Remote Control

The Audionet Metal Remote Control *RC 1* (included) or *RC 2* controls all the important function of everyday use of your SAM G2. The following explains all these commands in detail.

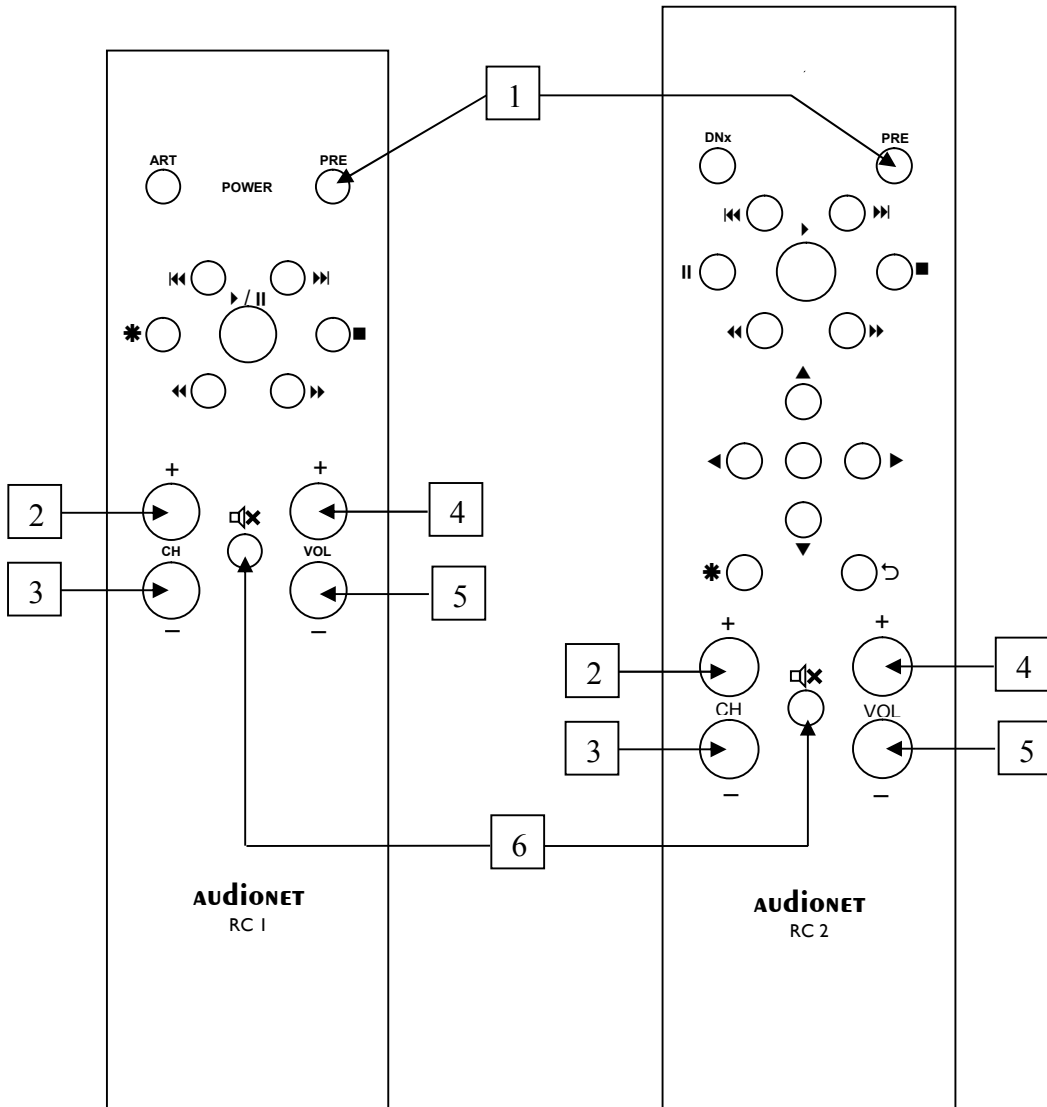

8.1 Key assignment SAM G2

- 1 Power key PRE**
use the key **PRE** to switch on / off your SAM G2. This key has the function as key **power** on the front panel. If the SAM G2 is in stand-by mode, press key **PRE** to switch on this unit. If the SAM G2 is already switched on, then pressing **PRE** powers the unit down to stand-by mode.
- 2 Key CH +**
selects the next input channel of the SAM G2.
- 3 Key CH -**
selects the previous input channel of the SAM G2.
- 4 Key VOL +**
increases the volume of the SAM G2.
- 5 Key VOL -**
decreases the volume of the SAM G2.
- 6 Mute key **
mutes the SAM G2. Press again to resume last volume level.

8.2 Changing the batteries

In order to exchange the batteries of your Audionet Metal Remote Control *RC 1* or *RC 2*, first you have to remove the 6 Phillips head screws on the bottom side.

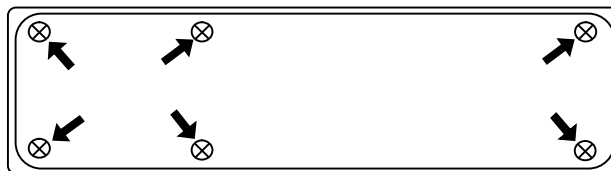

The battery compartment is to the left side of the circuit board. You need 2 batteries type 'AAA' or 'Micro' with a voltage of 1.5V.

Battery compartment

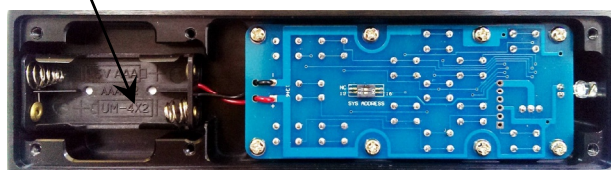



Important

- While inserting the batteries please mind their orientation. The correct orientation is printed onto the bottom of the battery compartment.

8.3 Settings for Audionet preamplifier

The Audionet Metal Remote Control *RC 1* or *RC 2* has 6 keys to control an Audionet (pre-) amplifier like the SAM G2. The previous section 'Key assignment SAM G2' explains the function of these keys.

Depending on their type, Audionet (pre-) amplifiers use different system addresses for their remote control code. A DIP switch on the circuit board of the Audionet Metal Remote Control *RC 1* or *RC 2* selects the desired system address.

In order to set the system address you first have to open up the remote control (see section 'Changing the batteries' on page 27).

For Audionet Metal Remote Control *RC 1* the DIP switch for selecting the system address is located here:

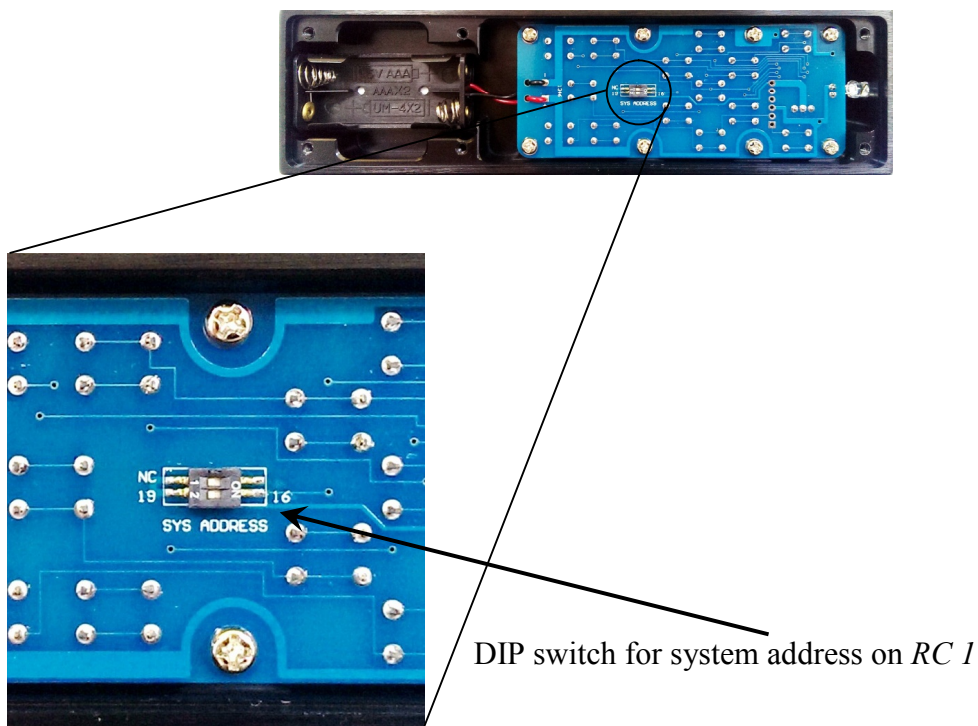

For Audionet Metal Remote Control *RC 2* the DIP switch for selecting the system address is located here:

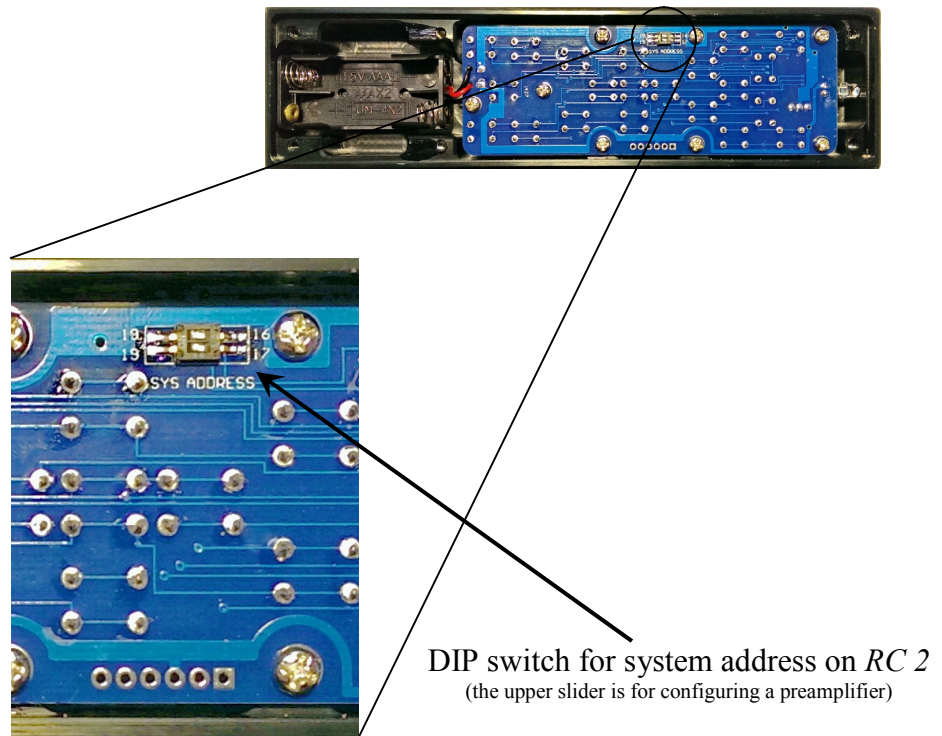

Put the DIP switch labelled 'SYS ADDRESS' in position '19' or '16' according to the following table:

Audionet preamplifier	Address
PRE G2, PRE 1 G3, SAM G2 , DNA, DNP, DNA 1	19
MAP 1	16



Note

- If not ordered explicitly, the Audionet Metal Remote Control is pre-configured to setting '19' of the DIP switch.
- Older models of Audionet preamplifiers use system address 16.
- Audionet Metal Remote Control *RC 2* uses both slider switches of the DIP switch. The one for configuring the preamplifier is the upper one with the left side labelled '19' and the right side labelled '16'.

9 Protection system

Your Audionet SAM G2 and your loudspeakers are protected by a complex protection circuitry. In case of a malfunction the display informs the user about the nature of the detected error in plain text:

Error message	Possible cause
Overload	short circuit or defective speaker
Overheating	ventilation slots covered
High Frequency	defective pre amplifier-stage
DC Voltage	exceeding DC level at the output: defective pre amplifier-stage or source unit
Power Failure	(temporary) breakdown of mains

Even after powering down the SAM G2, the error message will still be in the display. Press the **power** key on the front panel to indicating the stand-by mode.



Important

- Remove cause of error prior to switching on the SAM G2 again!

10 Technical information

10.1 Design

With circuits consequently designed using SMD miniature technology and shortening all signal paths to a minimum the high frequency characteristics were optimized. Ground pathways run in a star-shaped pattern converging in one central location. The circuit design is optimized capacitively and inductively. A powerful microprocessor controls and monitors the system.

10.2 Power Supply

The mains supply is extremely potent and very fast. This is guaranteed by a capped and fused 700 VA toroidal transformer, selected main filter capacitors with a total of 96.000 μ F smoothing capacity, a specially developed input filter and highly pure silver cabling as well as a capacitively optimized layout with the shortest of supply routes.

10.3 Circuitry

The circuitry of the SAM G2 is complex, technically unique and radically realized. The input signals are received from gold plated, Teflon isolated cinch jacks and then fed through gold-doped pure silver solid core signal cabling and gold-contacted double anchor precision relays, which switch the input signals. Each channel of the symmetrical input signals is un-balanced separately.

10.4 Operation

The SAM G2 is controlled via a high-performance flash microcontroller. Software upgrades are very easy. The controller makes for simple operation, comfortable functions and reassuring stability. The control programme enables operator-friendly access to comprehensive and practice-oriented functions. For example, the two pre-stage outputs and headphones output can be switched electronically. A by-pass mode is available for smart integration of the new SAM G2 into a home cinema system. The inputs are freely nameable and the controller even verifies that the mains connection is phase correct. Moreover, the controller monitors all operating states and deactivates the device as soon as a critical state has been identified. A large graphics-capable display with max. 4 x 26 characters informs the operator of all operating states and settings. The SAM G2 surely is equipped with AudionetLink. This enables the isolated activation of other Audionet devices via fibre-optics.

You may expand your SAM G2 with the Phono Module for MM and MC pickups.

11 Security advice



Important

- Avoid packaging material, especially plastic bags, coming into children's hands!
- Store and operate the unit in a dry room at a reasonable room temperature only!
- Avoid moisture, any liquids, dirt or small objects getting into the unit!
- Set up the unit in a sufficiently ventilated environment!
- Do not cover the unit!
- Do not open the unit. Unauthorised opening will void warranty!
- Do not short-circuit the outputs!
- During connecting or removing the SAM G2 to/from sources and/or power/pre amplifiers all units have to be switched off to prevent damage of the SAM G2 or any of the other connected units.
- Use dry cloth for cleaning!

We would like to wish you many exciting listening experiences with your new Audionet product.

If you still have any questions, do not hesitate to ask your Audionet dealer or contact us directly

12 Technical data

Type	Analog integrated stereo amplifier
Output power	2 x 115 W into 8 Ω 2 x 210 W into 4 Ω
Frequency response	0 - 500,000 Hz (-3 dB)
Damping factor	typ. 1000 at 100 Hz
Harmonic distortion	k2 typ. -101 dB, k3 typ. -106 dB, @1 kHz, 25 W/4 Ω
THD+N	< -100 dB @1 kHz, 25 W/4 Ω
Channel separation	> 93 dB @ 1 kHz
SNR	> 103 dB
Filtering capacitance	96,000 μ F
Inputs	5 pairs RCA line, gold plated, Teflon insulated 1 pair XLR balanced, gold plated (Neutrik)
Input impedance	Line input 10 k Ω XLR input 3 k Ω , 170 pF
Outputs	2 pair Furutech 4mm-jacks, Rhodium 1 pair RCA, gold-plated, Teflon insulated (Pre Out) 1 pair RCA, gold-plated, Teflon insulated (Rec Out) 1 Audionet Link, optical (TosLink) 1 6,3 mm socket for headphones (switchable)
Mains	220 V..240 V or 110..120 V, 50..60 Hz
Power consumption	< 1 W Stand-by, max. 30 W
Dimensions	Width 430 mm Height 110 mm Depth 360 mm
Weight	15 kg

Finish	<p>Front: brushed aluminium, 10 mm, black anodized, light grey printing or brushed aluminium, silver anodized, black printing</p> <p>Display: red or blue</p> <p>Cover: aluminium, 2 mm, black anodized</p> <p>Plates: aluminium, 8 mm, black anodized</p> <p>Chassis: 2 mm sheet steel, black varnished</p>
Features	<ul style="list-style-type: none"> - automatic detection of mains polarization - separate power supply for digital and analog sections - full DC coupling, no capacitors in the signal path - By-Pass function (e.g. for integration into home cinema systems) - Audionet Link output for remote control of other Audionet components - Switchable headphones output
Options	<ul style="list-style-type: none"> - MC/MM phono pre amplifier module

Errors and omissions excepted. Specifications and design are subject to changes without prior notice

AUDIONET

audionet GmbH

Brundbütteler Damm 140 B

13581 Berlin, Germany

www.audionet.de

kontakt@audionet.de

Errors and omissions excepted. Specifications and design are subject to changes without prior notice.